

Composite Vessels

The non-corrosive, cost-effective solution for commercial / industrial water treatment and storage.

The Composite pressure vessels offer composite fiberglass construction for outstanding performance and durability in harsh chemical environments. With capacities up to 1600 gallons and a variety of options, we can tailor a vessel to meet your needs. All our Composite vessels are warranted for 5 years.



All Composite tanks are warranted to be free from defects in materials and workmanship for a period of 5 years from the date of manufacture if the vessel is operated within the prescribed pressure and temperature ratings stated on the tank label.

Not covered by this warranty is damage resulting from freezing, external impact, chemical attack from liquid and gasses, exposure to vacuum, natural disasters, or other applications of the product beyond residential water softeners and filters.

Material of construction

Inner shell material: Polyethylene

Operating parameters

Maximum operating pressure: 150 psi

Maximum operating temperature: 150°F

Design parameters – Safety factor: 4:1 (Minimum burst at 600 psi)

Cycle test: 250,000 cycles without leakage

Design parameters – NSF

Safety factor: 4:1 (Minimum burst at 600 psi)

Cycle test: 100,000 cycles without leakage

Design parameters – ASME

Safety factor: 5:1 Top/bottom flange (Minimum burst at 750 psi) 6:1 Side flange (Minimum burst at 900 psi)

Cycle test: 33,000 cycles without leakage (Top/bottom flange)

100,000 cycles without leakage (Side flange)

ASME



Composite Specifications

	Part No.	Description	Height w/ base Inches / mm	Height w/o base Inches / mm	Capacity Gallons / Liters	Cubic Feet	Top Open	Bottom Open	Top Side	Bottom Side	Base	Ship Weight
18" Diameter	30948	18 x 65	67.1 / 1704	66.5 / 1689	62.4 / 236	8.3	4"- 8" UN	N/A	N/A	N/A	standard	67.7
	31343	18 x 65	79.8 / 2027	63.3 / 1608	62.4 / 236	8.3	4"- 8" UN	4"- 8" UN	N/A	N/A	tripod	79.7
	31693	18 x 65	84.4 / 2144	70.0 / 1778	62.4 / 236	8.3	6" FLG	6" FLG	N/A	N/A	tripod	79.7
21" Diameter	30949	21 x 36	41.7 / 1059	38.2 / 970	45.3 / 171	6.1	2.5" NPSM	N/A	N/A	N/A	standard	46
	30950	21 x 36	41.7 / 1059	38.2 / 970	45.3 / 171	6.1	4"- 8" UN	N/A	N/A	N/A	standard	46
	31573	21 x 36	54.5 / 1386	38.2 / 970	45.3 / 171	6.1	4"- 8" UN	4"- 8" UN	N/A	N/A	tripod	46
	30953	21 x 62	66.9 / 1699	62.6 / 1590	82.4 / 312	11.0	4"- 8" UN	N/A	N/A	N/A	standard	90
	30954	21 x 62	79.0 / 2006	62.6 / 1590	82.4 / 312	11.0	4"- 8" UN	4"- 8" UN	N/A	N/A	*tripod	90
24" Diameter	31043	24 x 38	42.0 / 1059	38.5 / 978	61.0 / 231	8.2	4"- 8" UN	N/A	N/A	N/A	standard	46
	31053	24 x 50	55.6 / 1412	51.5 / 1308	83.5 / 316	11.2	4"- 8" UN	N/A	N/A	N/A	standard	83.5
	31611	24 x 50	68.4 / 1738	52.9 / 1344	83.5 / 316	11.2	4"- 8" UN	4"- 8" UN	N/A	N/A	*tripod	83.5
	32049	24 x 65	64 / 1626	60.5 / 1537	100 / 378	13.4	4"- 8" UN	N/A	N/A	N/A	standard	100
	32481	24 x 65	75.7 / 1924	60.0 / 1524	100 / 378	13.4	4"- 8" UN	4"- 8" UN	N/A	N/A	*tripod	100
	32129	24 x 65	66.5 / 1689	62.6 / 1590	100 / 378	13.4	6" FLG	N/A	N/A	N/A	standard	100
	32139	24 x 65	79.0 / 2008	65.0 / 1651	100 / 378	13.4	6" FLG	6" FLG	N/A	N/A	tripod	100
	31153	24 x 72	74.1 / 1882	70.6 / 1793	119 / 450	15.9	4"- 8" UN	N/A	N/A	N/A	standard	139
	31154	24 x 72	84.5 / 2147	69.0 / 1753	119 / 450	15.9	4"- 8" UN	4"- 8" UN	N/A	N/A	*tripod	139
	31155	24 x 72	76.8 / 1951	73.3 / 1862	119 / 450	15.9	6" FLG	N/A	N/A	N/A	standard	149
	31157	24 x 72	88.9 / 2258	74.5 / 1892	119 / 450	15.9	6" FLG	6" FLG	N/A	N/A	tripod	149
30" Diameter	31161	30 x 72	85.9 / 2182	70.2 / 1783	187 / 708	25.0	4"- 8" UN	4"- 8" UN	N/A	N/A	*tripod	234
	31162	30 x 72	80.8 / 2052	73.0 / 1854	187 / 708	25.0	6" FLG	N/A	N/A	N/A	standard	240
	31163	30 x 72	89.0 / 2260	74.7 / 1897	187 / 708	25.0	6" FLG	6" FLG	N/A	N/A	tripod	240
36" Diameter	31417	36 x 57	70.5 / 1791	60.0 / 1524	205 / 776	27.4	6" FLG	N/A	N/A	N/A	standard	160
	31418	36 x 57	77.4 / 1966	63.0 / 1600	205 / 776	27.4	6" FLG	6" FLG	N/A	N/A	tripod	160
	31523	36 x 72	86.2 / 2190	70.5 / 1791	264 / 999	35.3	4"- 8" UN	4"- 8" UN	N/A	N/A	*tripod	292
	31214	36 x 72	83.0 / 2108	73.5 / 1867	264 / 999	35.3	6" FLG	N/A	N/A	N/A	standard	292
	31217	36 x 72	90.3 / 2294	75.0 / 1905	264 / 999	35.3	6" FLG	6" FLG	N/A	N/A	tripod	292
	31712	36 x 72	90.3 / 2294	75.0 / 1905	264 / 999	35.3	6" FLG	6" FLG	4" FLG	4" FLG	tripod	292
42" Dia.	31272	42 x 72	94.5 / 2401	71.0 / 1803	345 / 1306	46.1	6" FLG	N/A	N/A	N/A	tripod	678
	31276	42 x 72	94.6 / 2404	73.0 / 1854	345 / 1306	46.1	6" FLG	6" FLG	N/A	N/A	tripod	678
	See Factory	42 x 72	72.0 / 1828	71.0 / 1803	345 / 1306	46.1	6" FLG	N/A	N/A	N/A	short SMC	xxx

*Measurements are subject to change without notice and are for reference only.

Color Options: AL - Almond BL - Blue BK - Black GR - Gray NA - Natural



Composite Vessels

	Part No.	Description	Height w/ base Inches / mm	Height w/o base Inches / mm	Capacity Gallons / Liters	Cubic Feet	Top Open	Bottom Open	Top Side	Bottom Side	Base	Ship Weight
48" Diameter	31281	48 x 72	92.1 / 2339	76.0 / 1930	463 / 1753	61.9	6" FLG	N/A	N/A	N/A	tripod	780
	31285	48 x 72	92.1 / 2339	77.0 / 1955	463 / 1753	61.9	6" FLG	6" FLG	N/A	N/A	tripod	780
	31647	48 x 72	93.8 / 2383	78.0 / 1981	463 / 1753	61.9	16" MWY	6" FLG	N/A	N/A	tripod	780
	31283	48 x 72	96.1 / 2441	80.8 / 2052	463 / 1753	61.9	6" FLG	6" FLG	4" FLG	4" FLG	tripod	780
	31432	48 x 72	97.5 / 2477	81.7 / 2075	463 / 1753	61.9	16" MWY	6" FLG	4" FLG	4" FLG	tripod	780
63" Diameter	31390	63 x 67	79.5 / 2324	67.0 / 1702	600 / 2271	80.2	6" FLG	6" FLG	N/A	N/A	tripod	900
	Call Factory	63 x 67	79.5 / 2324	67.0 / 1702	600 / 2271	80.2	10" FLG	6" FLG	N/A	N/A	tripod	*
	31290	63 x 67	80.3 / 2344	67.8 / 1722	600 / 2271	80.2	16" MWY	6" FLG	N/A	N/A	tripod	900
	32008	63 x 67	80.3 / 2344	67.8 / 1722	600 / 2271	80.2	16" MWY	10" FLG	N/A	N/A	tripod	900
	31326	63 x 86	96.6 / 2758	84.1 / 2136	850 / 3218	114	6" FLG	6" FLG	N/A	N/A	tripod	1425
	32678	63 x 86	96.6 / 2758	84.1 / 2136	850 / 3218	114	6" FLG	6" FLG	4" FLG	4" FLG	tripod	1425
	32253	63 x 86	96.6 / 2758	84.1 / 2136	850 / 3218	114	10" FLG	6" FLG	N/A	N/A	tripod	1200
	31327	63 x 86	97.0 / 2769	84.5 / 2146	850 / 3218	114	16" MWY	6" FLG	N/A	N/A	tripod	1200
	31292	63 x 86	97.0 / 2769	84.5 / 2146	850 / 3218	114	16" MWY	6" FLG	4" FLG	4" FLG	tripod	1425
	32356	63 x 86	97.0 / 2769	84.5 / 2146	850 / 3218	114	16" MWY	10" FLG	N/A	N/A	tripod	1425
	32500	63 x 116	128.5 / 3264	116.0 / 2946	1250 / 4732	167	16" MWY	6" FLG	N/A	N/A	tripod	1425
	31325	63 x 116	128.5 / 3264	116.0 / 2946	1250 / 4732	167	16" MWY	6" FLG	4" FLG	4" FLG	tripod	1775
	Call Factory	63 x 116	128.5 / 3264	116.0 / 2946	1250 / 4732	167	16" MWY	10" FLG	N/A	N/A	tripod	*
	31456	63 x 144	158.5 / 4026	146.0 / 3708	1600 / 6057	214	16" MWY	6" FLG	N/A	N/A	tripod	2025
	31607	63 x 144	158.5 / 4026	146.0 / 3708	1600 / 6057	214	16" MWY	6" FLG	4" FLG	4" FLG	tripod	2025
	31664	63 x 144	158.5 / 4026	146.0 / 3708	1600 / 6057	214	16" MWY	10" FLG	N/A	N/A	tripod	2025

*Measurements are subject to change without notice and are for reference only.

Color Options: AL - Almond BL - Blue BK - Black GR - Gray NA - Natural



NOTE: See flex connection and vacuum breaker information on page 13.



Installation Tips:

- Bolt base to floor
- Calculate height for valve and base combined (see photo)

Fleck Valve	Tank Dia. Inches / mm	Adder Ht. (X) Inches / mm
2750	18 / 457	6.5 / 165
2850	21 / 533	6.5 / 165
2900	24, 30 / 610, 762	12 / 305
2930	36 / 914	13 / 330
3150	42 / 1067	10 / 254
3900	48-63 / 1219-1600	15 / 381

Composite Specifications

Dome Volume (gallons) and Straight Wall Gallon per Inch

D (inches)	Nominal Diameter		A (Sq. Feet)
	Gallons* (One Dome)	Gallon / Inch (Approx.)	
12	1.0	0.5	0.7
13	1.4	0.5	0.9
14	1.7	0.6	1.1
16	2.7	0.8	1.3
18	3.7	1.0	1.8
21	6.2	1.4	2.4
24	9.3	1.9	3.0
30	18	2.9	4.6
36	33	4.2	6.7
42	52	5.7	9.0
48	74	7.5	12.0
63	168	13.0	20.0

*Cubic Ft. = 0.1337 x Gallons

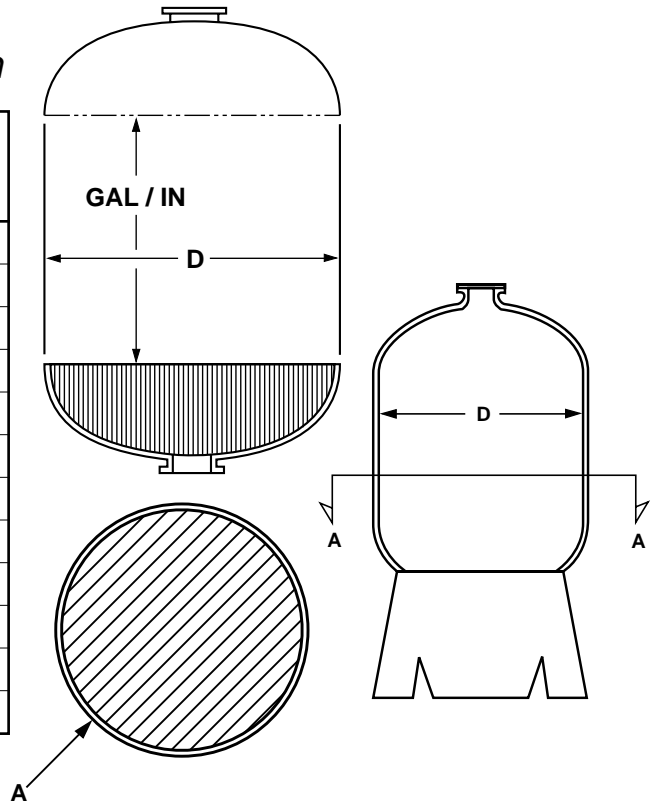

Vacuum Breaker Installation

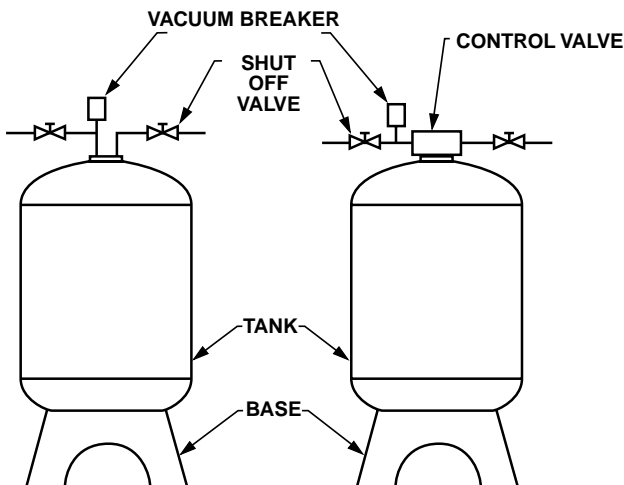

Flex Connectors Installation

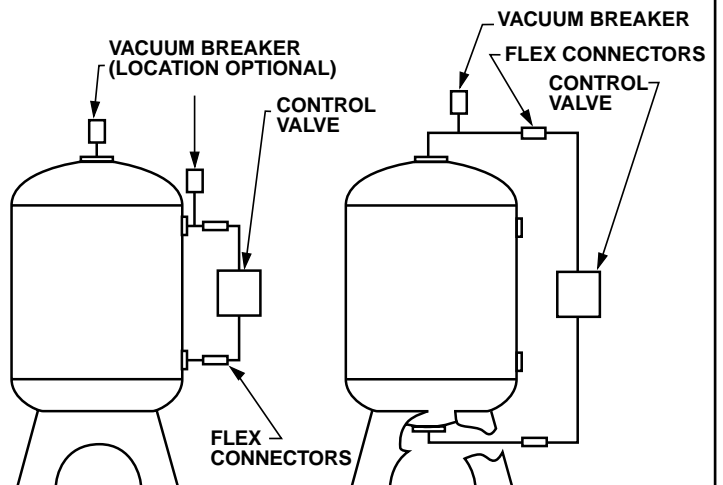

NOTE: Flexible connectors must be installed between hard piping and tank openings. These pressure vessels are rated for an internal negative pressure of 5" HG (17 Pa) vacuum below atmospheric. If negative pressure could ever exceed 5" Hg (17 Pa), an adequate vacuum breaker must also be properly installed. Failure to install flex connection properly, or improper installation of a vacuum breaker when required, may void the warranty.

Composite Vessels

Top and Bottom Opening Threads

Size	Composite/ Polyglass	Number of Full Threads	Composite
2.5"- 8" NPSM	6	3 min	6
4"- 8" UN	7	3 min	7
4.5"- 8" Buttress	7	3 min	7

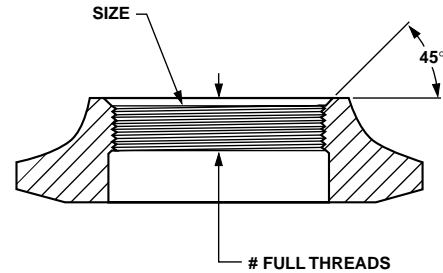

Top and Bottom Opening Flanges/Manway

Size	L	I.D.	B.C.	O.D.	A Bolt Dia.	Number of Holes	Weight (lbs.)
6" SNA	3.6"	5.9"	8.5"	9.4"	0.31"	12	5.8
10" ANSI	3.7"	10.0"	14.3"	16.0"	0.88"	12	17.8
16" Manway SNA	4.3"	16.0"	20.4"	21.3"	0.50"	24	34.0

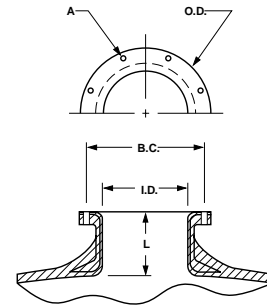

Manway Cover

Material	Pressure Rating	Tapping
CPVC	100 psi	As requested
VE	150 psi	As shown only

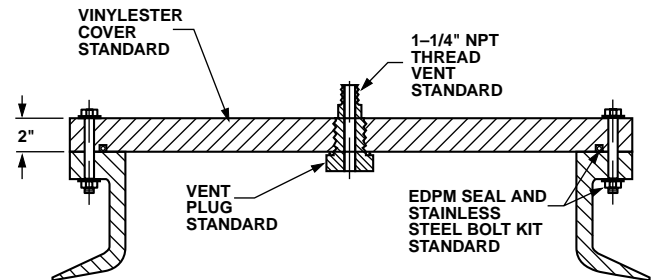

Side Flange

Size	L	I.D.	B.C.	O.D.	B Bolt Dia.	Number of Holes	Weight (lbs.)
4" ANSI	4.1"	4.0"	7.5"	9.0"	0.63"	8	6.4

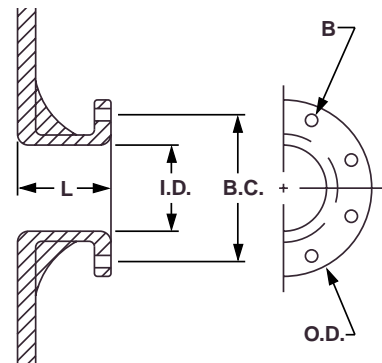

Chemical Resistance

A unique feature of our pressure vessel is its construction and use of a leak-proof pressure vessel liner. The liner is made from FDA-approved, highly stress- and crack-resistant, UV-inhibited polyethylene.

Chemical Description	Inner Shell Material			
	Polyethylene	Polypropylene	PVDF	ECTFE
Air	Excellent	Excellent	Excellent	Excellent
Aluminum Chloride 20° C	Excellent	Excellent	Excellent	Excellent
Ammonia 20° C	Excellent	Excellent	(Gas) Very Good	Very Good
Arsenic 20° C	Excellent	Excellent	No Data	No Data
Arsenic Acid 20° C	Excellent	No Data	Excellent	Excellent
Benzene 20° C	Poor	Fair	(38° C) Very Good	Excellent
Bleach 20° C	Very Good	No Data	No Data	Excellent
Bleach Warm	Fair	No Data	Fair	Excellent
Bromine Water 20° C	Very Good → Excellent	Poor → Fair	Excellent	Excellent
Calcium Carbonate	Excellent	Excellent	Excellent	Excellent
Carbonic Acid 20° C	Excellent	Excellent	Excellent	Excellent
Caustic Soda 20° C	Excellent	Excellent	Excellent	No Data
Chlorine (Liquid)	Fair	Fair	Excellent	Excellent
Chromic Acid 20° C	Excellent	Very Good	Excellent	Excellent
Copper Sulfate	Excellent	Excellent	Excellent	Excellent
Ferric Chloride 20° C	Excellent	Excellent	Excellent	Excellent
Fluorine 20° C	Fair	Poor	Very Good → Excellent	Excellent
Freon 11 20° C	No Data	No Data	Excellent	Excellent
Hydrochloric Acid 20° C	Very Good → Excellent	Very Good → Excellent	Very Good → Excellent	Excellent
Hydrofluoric Acid 20° C	Excellent	Excellent	Very Good	Excellent
Hydrogen Peroxide 20° C	Excellent	Excellent	Excellent	Excellent
Lime Chloride	Excellent	No Data	No Data	No Data
Magnesium Salts 20° C	Excellent	Excellent	Excellent	No Data
Methyl Chloride 20° C	Good	Fair	Very Good → Excellent	Excellent
Nitric Acid 20° C	Poor	Fair	Very Good → Excellent	Very Good → Excellent
Ozone (4 ppm) 20° C	Good	Fair	Very Good → Excellent	Excellent
Photographic Solutions	Excellent	Excellent	No Data	Excellent
Plating Solutions	Good → Very Good	Excellent	Excellent	Excellent
Potassium Carbonate 20° C	Excellent	Excellent	Excellent	Excellent
Potassium Sulfate 20° C	Excellent	Excellent	Excellent	Excellent
Sodium Bicarbonate 20° C	Excellent	Excellent	Excellent	Excellent
Sodium Carbonate 20° C	Excellent	Excellent	Excellent	Excellent
Sodium Chloride	Excellent	Excellent	Excellent	Excellent
Sodium Fluoride 20° C	Excellent	Excellent	Excellent	Excellent
Sodium Sulfate 20° C	Excellent	Excellent	No Data	Excellent
Sodium Sulfide 20° C	Excellent	Excellent	No Data	Excellent
Sodium Sulfite 20° C	Excellent	Excellent	No Data	Excellent
Sea Water	Excellent	Excellent	Very Good	Excellent
Steam	Excellent	No Data	No Data	No Data
Sulfuric Acid 10%, 20° C	Good → Very Good	Excellent	Good → Very Good	Good → Very Good
Sulfuric Acid 20%, 20° C	No Data	Excellent	No Data	Excellent
Sulfuric Acid 50%, 20° C	Excellent	Excellent	Excellent	Excellent
Sulfuric Acid 76-97%, 20° C	Good	Good	Excellent	Excellent
Toluene 20° C	Poor	Poor	Very Good	Excellent
Trichlorobenzene 20° C	Fair	No Data	Excellent	Good
Zinc Chloride 20° C	No Data	No Data	Excellent	Excellent
Zinc Oxide 20° C	Excellent	Excellent	No Data	No Data
Zinc Sulfate 20° C	Excellent	Excellent	Excellent	Excellent

* This is a general indicator of the polymer's resistance to certain chemicals. When there is doubt or in critical applications, we recommend ASTM Test D-543.

Composite Vessels

Units	English or Metric	Circle or fill in appropriate data					
Pressure	PSI or kPa	min.					max.
Temperature	° F or ° C	min.					max.
Liner Material		PE					
Volume	Gallons or Liters						
Height Constraint (H)	Inches or mm						
Width Constraint (W)	Inches or mm						
Pressure Vessel Diameter	Inches	12"	13"	14"	16"	18"	21"
		24"	30"	36"	42"	48"	63"
Pressure Vessel Length	Inches or mm	For standard lengths, refer to Specification pages.					
Top Opening	A1	2.5" NPSM	4"-8" UN	4.5"-8" Buttress	6" SNA Flange	10" ANSI Flange	16" SNA Manway
Bottom Opening	A2	2.5" NPSM	4"-8" UN	4.5"-8" Buttress	6" SNA Flange	10" ANSI Flange	16" SNA Manway
Side Top Opening	A3	36" 48" 63" Diameter Only			4"		
Side Bottom Opening	A4	36" 48" 63" Diameter Only			4"		
Distributor - Top		Diffuser		High Flow			
Distributor - Side Top		Diffuser		High Flow			
Distributor - Side Btm.		Hub & Lateral		Fishbone		High Flow	
Distributor - Bottom		Hub & Lateral		Fishbone		High Flow	
Pressure Vessel Base		None	Standard	Extended	Tripod		
Flange Covers		VE	CPVC	Noryl	Other :		
O-Ring Material		EPDM	VITON	Other :			
Vessel Contents		Please list.					
Pressure Vessel Color		Natural	Almond	Blue	Black	Gray	
Vessel Quantity		Number of Units :					
ASME Code		Yes	No				

